

- Placement of clamps and roof bars
- Placement des pattes fixation et d barres de toit
- Platzierung der Klemmen und bars
- Colocación de las grapas de fijación en las barras de techo

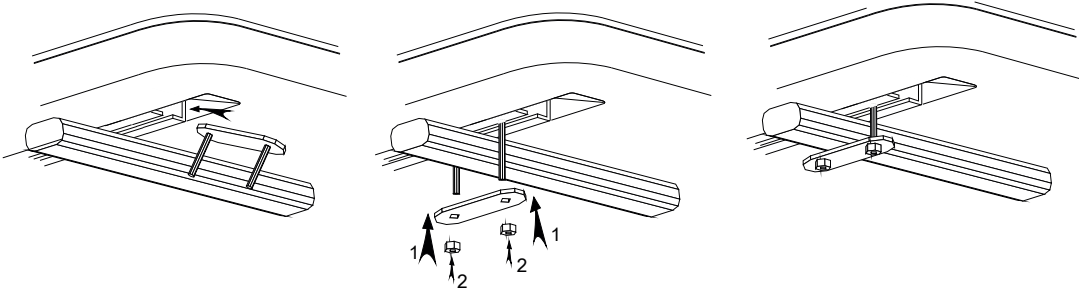

- Position and distribution of the roof racks
- Positionnement et la distribution des barres de toit
- Positionierung und den Vertrieb von Dachtrager
- Posición y distribución de las barras de techo

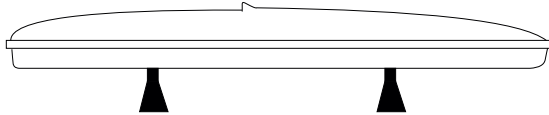

- With 2 Bars
- Avec 2 barres
- Mit 2 Bars
- Con 2 barras

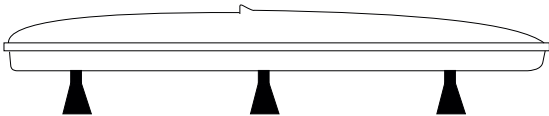

- With 3 Bars
- Avec 3 barres
- Mit 3 Bars
- Con 3 barras

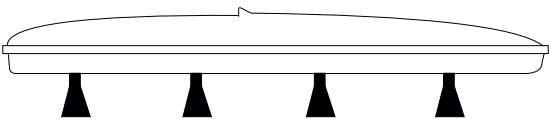

- With 4 Bars
- Avec 4 barres
- Mit 4 Bars
- Con 4 barras

(Minimum weight supported by bar should be 45kg / Poids minimum supporté par barre devrait être 45kg / Mindestgewicht von 45kg unterstützt wird, sollte sein.)
(Peso mínimo soportado por barra deberá ser 45 kg)



ATTENTION!!

- EN/** Mattress placement instructions **FR/** Instructions de placement de matelas
- DE/** Matratze Platzierungsanweisungen **ES/** Instrucciones de colocación del colchón:

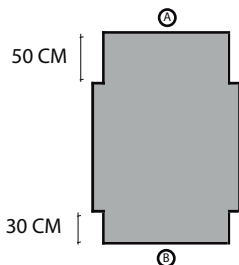

- EN/** After maintenance place the mattress on his original position
- FR/** Après l'entretien, placez le matelas sur sa position d'origine
- DE/** Nach der Instandhaltung die matratze auf die ursprüngliche position bringen
- ES/** Después del mantenimiento coloque el colchón en su posición original

(A)

- EN/** Tent front
- FR/** Arrière de la tente
- DE/** Zelt vorne
- ES/** Frente de la tienda

(B)

- EN/** Tent rear
- FR/** Tente arrière
- DE/** Zelt hinten
- ES/** Trasera de la tienda

James
BAROUD
OFF ROAD TENTS

- EN/** User Guide
- FR/** Guide de L'utilisateur
- DE/** Benutzerhandbuch
- ES/** Guía del usuario

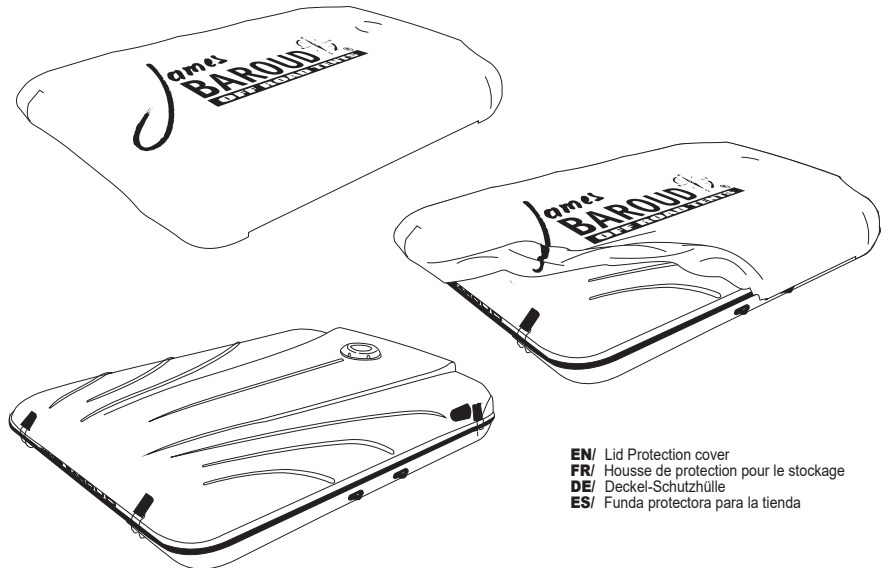

- EN/** Lid Protection cover
- FR/** Housse de protection pour le stockage
- DE/** Deckel-Schutzhülle
- ES/** Funda protectora para la tienda

Evasion / Evasion XXL / [REDACTED] / GrandRaid / GrandRaidXXL

OPEN

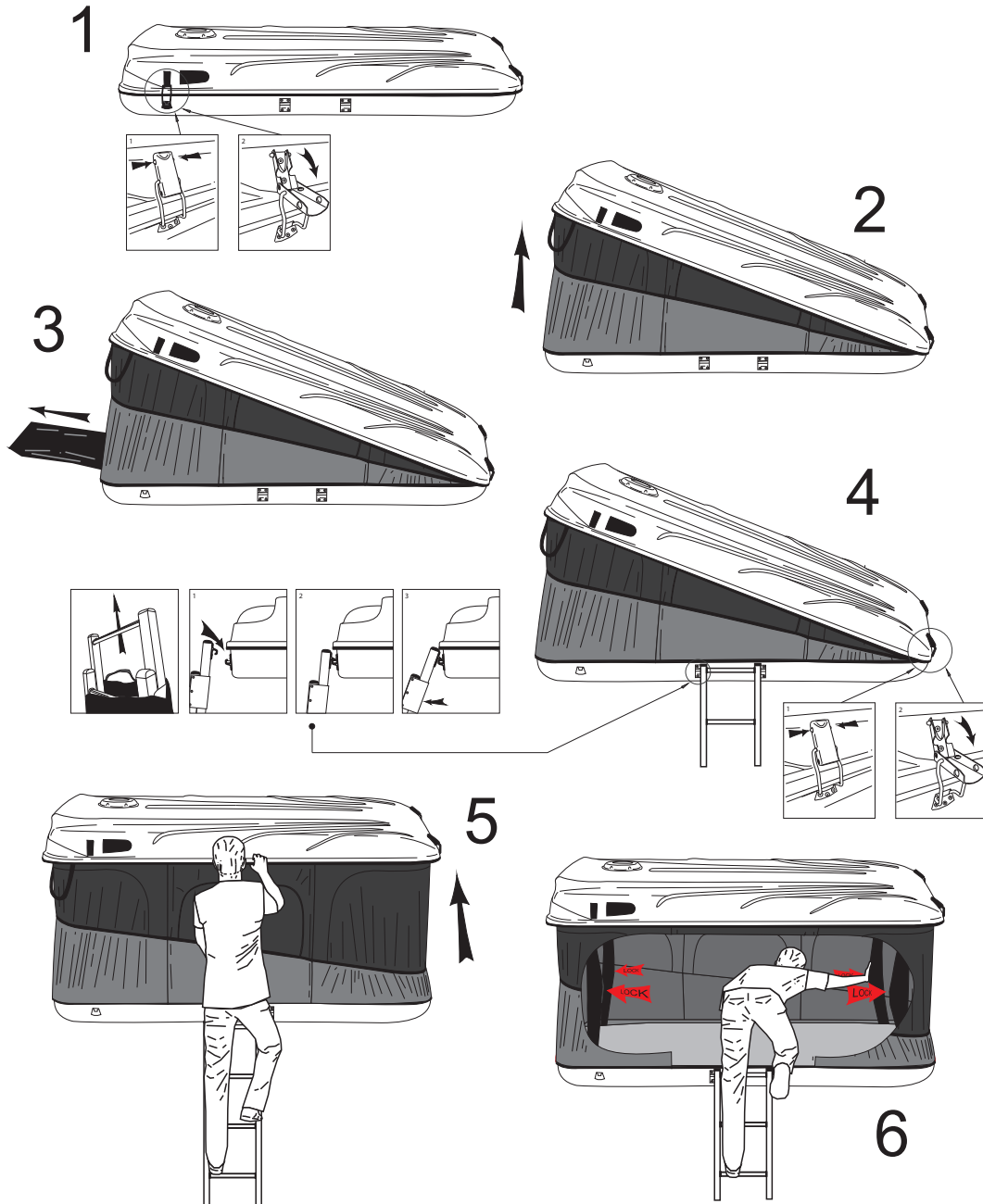

OPENING INSTRUCTIONS / INSTRUCTIONS D'OUVERTURE/ ERÖFFNUNGSVERFAHREN/ INSTRUCCIONES DE APERTURA

- | | | | | | |
|--|---|---|--|--|---|
| 1 EN/ Open rear latches
FR/ Ouvrir les fermetures arrière
DE/ Öffne hintere Riegel
ES/ Abrir los cierres traseros | 2 EN/ Open the tent rear
FR/ Ouvrir l'arrière de la tente
DE/ Öffnen Sie das Zelt Hinter
ES/ Abrir la parte trasera de la tienda | 3 EN/ Remove the ladder
FR/ Retirer l'échelle
DE/ Entfernen Sie die Leiter
ES/ Retirar la escalera | 4 EN/ Place the ladder / Open front latches
FR/ Placez l'échelle / Ouvrir les fermetures avant
DE/ Setzen Die Leiter/ Öffnen Sie vordere Riegel
ES/ Colocar la escalera/ Abrir los cierres delanteros | 5 EN/ Open the tent front
FR/ Ouvrir l'avant de la tente
DE/ Öffnen Sie das Zelt Vorder
ES/ Abrir la parte frontal de la tienda | 6 EN/ Lock the 4 arms
FR/ Bloquer les 4 bras de la tente
DE/ Sperren Sie die vier Arme
ES/ Bloquear los 4 brazos |
|--|---|---|--|--|---|

CLOSE

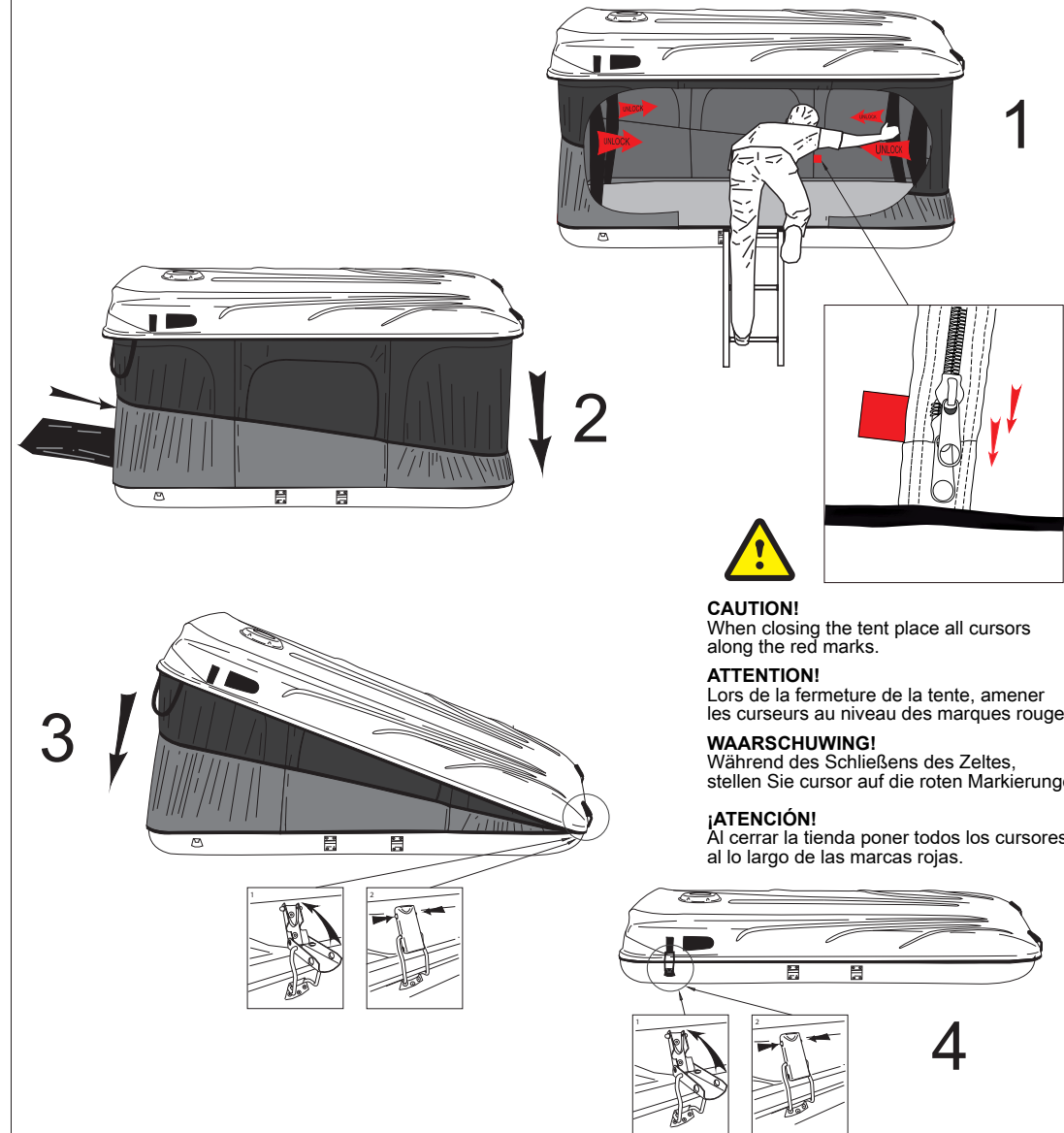

CLOSING INSTRUCTIONS / INSTRUCTIONS DE FERMETURE/ SCHLIEßENSVERFAHREN/ INSTRUCCIONES DE CIERRE

- | | | | |
|--|--|--|--|
| 1 EN/ Unlock the 4 arms
FR/ Débloquer les 4 bras
DE/ Lösen Sie die vier Arme
ES/ Desbloquear los 4 brazos | 2 EN/ Slow the ladder / Close the tent front
FR/ Ranger l'échelle / Fermer l'avant de la tente
DE/ Vereinbaren die leiter / Schließen Sie das Zelt Vorder
ES/ Guardar la escalera/ Cerrar la parte frontal de la tienda | 3 EN/ Close front latches / Close the tent rear
FR/ Fermer les fermetures avant / Fermer l'arrière de la tente
DE/ Schließen vordere Verriegelungen / Schließen Sie das Zelt Hinter
ES/ Cerrar los cierres delanteros/ Cerrar la trasera de la tienda | 4 EN/ Close rear latches
FR/ Fermer les fermetures arrière
DE/ Schließen hintere Riegel
ES/ Cerrar los cierres traseros |
|--|--|--|--|



CAUTION!
When closing the tent place all cursors along the red marks.

ATTENTION!
Lors de la fermeture de la tente, amener les curseurs au niveau des marques rouges.

WAARSCHUWING!
Während des Schließens des Zeltes, stellen Sie cursor auf die roten Markierungen.

¡ATENCIÓN!
Al cerrar la tienda poner todos los cursores al lo largo de las marcas rojas.